



COTTON STATE BARNs

TOP QUALITY PORTABLE BARNs



Built in ALABAMA for ALABAMA since 2002



COTTONSTATEBARNs.COM



At Cotton State Barns we remain dedicated to the old-fashioned precepts of **HONESTY, INTEGRITY, WORK ETHIC, and QUALITY**. These time-proven values are the bedrock of our company, and we strive to maintain them in everything we do!

From manufacturing to delivery, we want the craftsmanship and quality of our products to exceed every reasonable expectation, and the professionalism and courtesy of our service to be second to none!

Why set such high standards? Because it is the only way we can offer the best, most affordable storage solutions, and the only way we can deserve your trust!

AFTER ALL, HIGH-QUALITY, LONG-LASTING STORAGE BUILDINGS ARE WHAT WE DO, AND WE INSIST ON DOING THEM RIGHT!

THE DIFFERENCE IS OUR QUALITY!

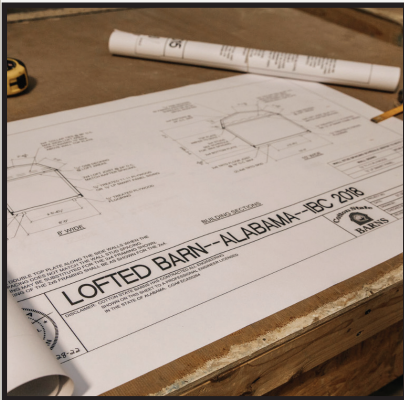

- ✔ We Ensure that All Exposed Natural Wood is Pressure-Treated (including trim, ground skids, floor joists, and natural wood siding)
- ✔ We Build All Our Roofs with 29 Gauge Metal or 30-Year Dimensional Shingles
- ✔ We Insist Our Floor Joists be Constructed of Sturdy 2"x6" Lumber Mounted on 4"x6" Notched Ground Skids Laid Out on 16" Centers (12" centers are standard in all garage models)
- ✔ We Offer Premium Sidings: LP Smartside®, 29 Gauge Metal, or T1-11
- ✔ We Construct Durable Floorings: 5/8" Pressure-Treated Plywood or 5/8" Tongue-n-Groove Smooth Finish
- ✔ We Install Diamond-Plated Thresholds on Most Models
- ✔ We Use Only Top-Quality Paints, Sealants, and Urethane
- ✔ We Use No-Rust Galvanized Ring-Shanked Nails
- ✔ We Install Hurricane Straps in Every Barn
- ✔ We Use Engineer Approved Metal Truss Connector Plates for Stronger, More Reliable Trusses (also used in our wood doors)
- ✔ We Include Rubber Door Stops (to prevent damage)
- ✔ We Provide Locks and Keys



LOFTED BARN

Lofted Barns come standard with:

- 78" Wall Height (much higher than industry standard)
- Lofts (can add up to 80% more storage space in same sq. footage area)
- Diamond-Plated Threshold
- 10' Wide and Wider - Double Wood Doors (70" opening)
- 8' Wide - Single Wood Door (46" opening)

**Non-Standard options shown here include Transom Doors, 6' Transom Window, and Loft Door.*



SIDE LOFTED BARN

Side-Lofted Barns come with the same standard features as Lofted Barns, but also:

- 10' Long - Single Wood Door with One 2'x3' Window
- 12' Long - Choice of Single Wood Door with Two 2'x3' Windows, or Double Wood Doors with One 2'x3' Window
- 14' Long and Longer - Double Wood Doors with Two 2'x3' Windows

**Non-Standard options shown here include Transom Doors, Shutters, and Octagon Windows.*



BARN

Barns come standard with:

- 46" Wall Height
- Double Wood Doors (a single 4' wood door if 8' wide)
- Diamond-Plated Threshold

**Pictured as standard. See pages 9 and 10 for a full selection of options you can add!*



Visit us online to learn more.
COTTONSTATEBARN.COM



UTILITY SHEDS

Utility Sheds come standard with:

- 10'x16' and Larger - 92" Wall Height and 7' Tall Double Wood Doors (70" opening)
- 10'x14' and Smaller - 75" Wall Height and 6' Tall Double Wood Doors (70" opening)
- 8' Wide - Single 6' Wood Door (46" opening)
- Diamond-Plated Threshold



GARDEN SHEDS

Garden Sheds come with the same standard features as Utility Sheds, but also:

- 10' Long - Single Wood Door with One 2'x3' Window
- 12' Long - Choice of Single Wood Door with Two 2'x3' Windows, or Double Wood Doors with One 2'x3' Window
- 14' Long and Longer - Double Wood Doors with Two 2'x3' Windows

**Non-Standard options shown here include Transom Doors and Shutters.*

**See Pages 9 & 10 for a full selection of these and many other options that can be added.*



COTTAGE SHEDS

Cottage Sheds come standard with:

- Classic Saltbox Roof
- Diamond-Plated Threshold
- 7' Wood Door(s)
- 10' Long - Single Wood Door and One 2'x3' Window
- 12' Long - Choice of Single Wood Door and Two 2'x3' Windows, or Double Wood Door and One 2'x3' Window
- 14' Long and Longer - Double Wood Doors and Two 3'x3' Windows



**Pictured as standard. See pages 9 and 10 for a full selection of options you can add!*

**14' and 16' wide models may be available in some areas.*



8' WIDE
BARN, LOFTED
BARN, UTILITY



10' LONG
SIDE LOFTED
BARN,
GARDEN SHED,
COTTAGE SHED



12' LONG
STANDARD SIDE
LOFTED BARN,
GARDEN SHED,
COTTAGE SHED



12' LONG
OPTIONAL SIDE
LOFTED BARN,
GARDEN SHED,
COTTAGE SHED



14' OR LONGER
SIDE LOFTED BARN,
GARDEN SHED



14' OR LONGER
COTTAGE SHED

CABINS

Our cabin line offers a variety of choices that can fit every budget!



DELUXE LOFTED BARN CABIN

Comes standard with Wrap-Around Porch, 5/4" Wood Porch Decking, 9-Lite Steel-Clad Walk-In Door, Four 2'x3' Windows, One 3'x3' Window, 78" Walls, Wood Railings, Lofts, 16" OC Wall Studs, Two Vents, and 2"x6" Floor Joists.



LOFTED BARN CABIN

Comes standard with 4' Front Porch, 5/4" Wood Porch Decking, 9-Lite Steel-Clad Walk-In Door, Three 2'x3' Windows, 78" Walls, Wood Railings, Lofts, 16" OC Wall Studs, Two Vents, and 2"x6" Floor Joists.



DELUXE CABIN

Comes standard with Wrap-Around Porch, 5/4" Wood Porch Decking, 9-Lite Steel-Clad Walk-In Door, Four 2'x3' Windows, One 3'x3' Window, 92" Walls, Wood Railings, 16" OC Wall Studs, Two Vents, and 2"x6" Floor Joists.



CABIN

Comes standard with 4' Front Porch, 5/4" Wood Porch Decking, 9-Lite Steel-Clad Walk-In Door, Three 2'x3' Windows, 92" Walls, Wood Railings, 16" OC Wall Studs, Two Vents, and 2"x6" Floor Joists.

**Non-Standard options shown here include Shutters, Octagon Windows, 4-Lite Walk-In Doors, 11-Lite Walk-In Doors, Vinyl Handrails, and Composite Porch Decking.*

**See Pages 9 & 10 for a full selection of these and many other options that can be added.*

Visit us online to learn more.
COTTONSTATEBARN.COM





GARAGES

Garages come standard with:

- 9' Roll-Up Door
- Diamond Plated Threshold
- 12" OC Floor Joists
- 36" Steel-Clad Walk-In Door
- 2'x3' Window

LOFTED BARN GARAGES

Lofted Barn Garages come with the same standard features as Garages, but also with lofts that can add up to 80% more storage space in the same square footage area (the lofts require 78" wall heights).

The standard 12" floor joists provide sturdy support for a wide variety of uses, while the 36" steel-clad walk-in door provides easy access.



**Non-Standard Options shown here include a 9' Panel Garage Door (instead of the standard 9' Roll-Up Door) and Shutters.*

**See Pages 9 & 10 for a full selection of these and many other options that can be added.*



TOOL SHEDS

Tool Sheds come standard with:

- 75" Rear-Wall Height
- 100" Minimum Front-Wall Height (varies with size of building)
- 7' Double Wood Doors (70" opening)
- Diamond-Plated Threshold

**Non-Standard options shown here include 6' Doors and three Transom Windows.*

**See Pages 9 & 10 for a full selection of these and many other options that can be added.*



PIONEER CABINS

Pioneer Cabins come standard with:

- Full-Length Porch
- 92" Wall Height
- 9-Lite Steel-Clad Walk-In Door
- Four 2'x3' Windows
- 16" OC Wall Studs
- 2"x6" Floor Joists

LOFTED PIONEER CABINS

Lofted Pioneer Cabins come with the same standard features as the Pioneer Cabin, but also with lofts, two octagon windows (one per end), ridge vents, and 78" walls.

This cabin can be upgraded with vinyl railing and composite decking to make this a long-lasting, one-of-a-kind storage barn.



**Non-Standard Options shown here include Shutters, 4-Lite Walk-In Doors and 5-Lite Walk-In Doors, Vinyl Handrails, and Composite Porch Decking.*

**See Pages 9 & 10 for a full selection of these and many other options that can be added.*



SUN STUDIOS

For hobbyists and crafters our new SUN STUDIO comes with many window options that let the sunlight in! Sun Studios come standard with:

- Three 10"x34" Transom Windows in Dormer
- 6' Transom Doors
- Two 2'x3' Windows
- Shutters

**Shutters not Standard on 16' wide front walls.*

**See pages 9 and 10 for a full selection of options you can add!*

Visit us online to learn more.

COTTONSTATEBARN.COM



LIVESTOCK SHELTERS



- Livestock Shelters come standard with Pressure-Treated Kickboards for greater animal protection.
- Tack Room (as shown) not standard.

**See dealer for details regarding additional stalls and dividers.*

CABANAS

Pictured as standard. LP Smart Siding, Composite Decking, Vinyl Railings, and an assortment of Paint and Urethane Colors are available - some for additional charges.



BUDGET SERIES

If affordability is the primary concern, our Budget Series Metal Barn offers the most for the least!

**No options such as Windows, Doors, or other Sidings can be substituted or added. In some areas we offer a limited choice of Custom Metal Colors (additional charges may apply).*

WE OFFER BUILD-ON-SITE

Our "BUILD-ON-SITE" option is a perfect solution when delivering one of our pre-built barns is not possible! Contact your nearest dealer for more information and current pricing.

**We cannot paint, stain, or seal Build-On-Site barns.*



CHOOSE YOUR LOOK:

PAINT



URETHANE

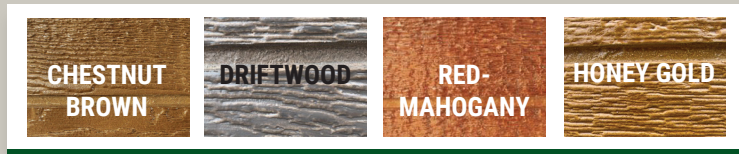

SHINGLES

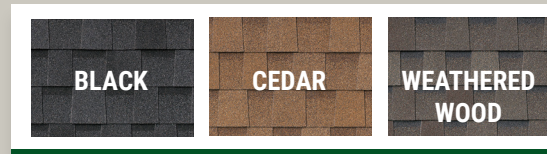

METAL

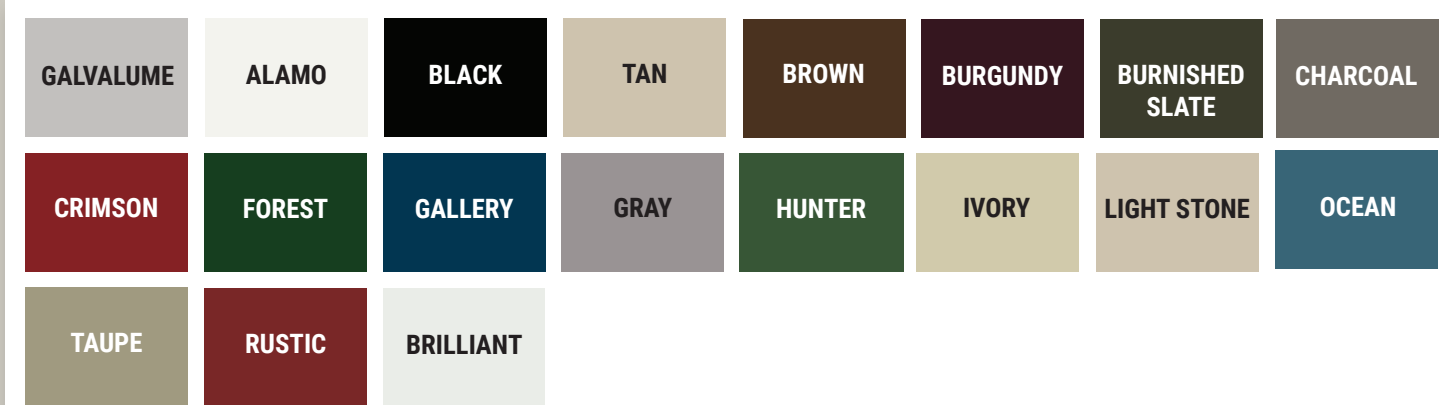

SIDING

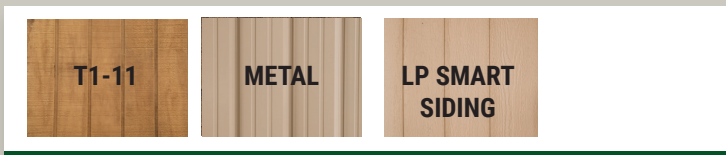

FLOORING

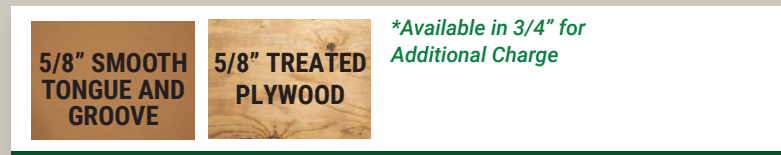

*ACTUAL COLORS MAY VARY. See dealer for actual color samples. We are not responsible for matching colors from printed or digital images. Availability of options, colors, materials and finishes may vary by region. Ask your dealer for details and pricing.

Visit us online to learn more.
COTTONSTATEBARN.COM



DOOR OPTIONS

ENTRY DOORS

Steel-Clad Door



4-Lite Door



5-Lite Door



9-Lite Door



11-Lite Door



BARN DOORS

*Double Doors are available in 6' or 7' height.

Single Door



6' or 7' Double Door

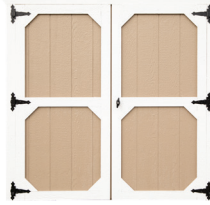

6' or 7' Double Transom



Working Loft Door



WINDOW OPTIONS

2'x3' Window



3'x3' Window



Transom Window



*Available in 29", 35", and 72" Width

Octagon Window



Shutters



*2'x3' and 3'x3' Windows available in Single Pane and Double Pane.

*Shutters available on all 2'x3' Windows and 3'x3' Windows.

INTERIOR OPTIONS

Loft



Shelves



Work Bench



Radiant Barrier



PORCH OPTIONS

Composite Decking



Vinyl Railing



GARAGE DOOR OPTIONS

Rollup Garage Door



Panel Garage Door



*Available in multiple sizes and colors.

MORE OPTIONS:

- 12" OC FLOOR JOISTS (standard in all garages)
- EXTRA SKID
- EXTRA HEIGHT (8'X12'-10'X14' GS/UT ONLY)
- RIDGE VENT
- VAPOR BARRIER (house wrap)
- THERMOFOIL INSULATION (double bubble)
- RADIANT BARRIER ROOF DECKING
- RADIANT BARRIER SIDING
- 160 MPH WIND RATING
- 70 LB. SNOW LOAD ROOF
- ADDITIONAL BENCHES (Cabana)
- EXTRA STALLS (Livestock Shelter)
- TACK ROOM (Livestock Shelter)



FREE DELIVERY AND SET UP!

We offer free delivery and set-up within a 50-mile radius of your dealer. No ground prep is necessary if site is no more than 3' out of level in any direction. Wooden leveling blocks will be provided free-of-charge to level your building provided your site is no more than 1' out of level in any direction (customer provided concrete blocks must be used if more than 1' out of level in any direction). All sites must be accessible to trucks, trailers, and set-up equipment, and RTO sites cannot require crossing adjacent properties for access.

All necessary permits (and/or legal requirements of any kind) regarding any aspect of purchasing or renting a Cotton State barn are the sole responsibility of the customer, as well as all determinations regarding ground conditions and site suitability. We are not - nor are our affiliates - responsible for any above ground or underground damages which may result from a delivery attempt, nor are we responsible for removing obstacles (such as fences, tree limbs, etc.).

**Visit our website at cottonstatebarns.com and click on the "Delivery" tab for more very important details regarding our delivery policies. (While we strive to maintain the shortest 'wait times' in the industry, these 'wait times' can vary due to weather, ground conditions, and seasonal demand).*



ENGINEER CERTIFIED!

Our standard non-metal barns are engineer-certified, meet IBC standards, and are classified as Minor Storage Facilities (Occupancy Category 1) that are not intended for any other use (metal barns are not certified, nor do we guarantee code compliance in every jurisdiction for any barn). Higher snow load and wind load packages can be added for an additional cost (see "Options" and/or ask dealer for details).

**Visit our website at cottonstatebarns.com and click on the "Engineer Certifications" tab for more very important details regarding our certifications, availability of plans, and other related policies and offerings.*

DIMENSIONS

Due to D.O.T. regulations our 12', 14', and 16' wide buildings are labeled with nominal values that are not the exact measurements of the interior or exterior widths (or eave widths) of our barns (eave widths vary by model).

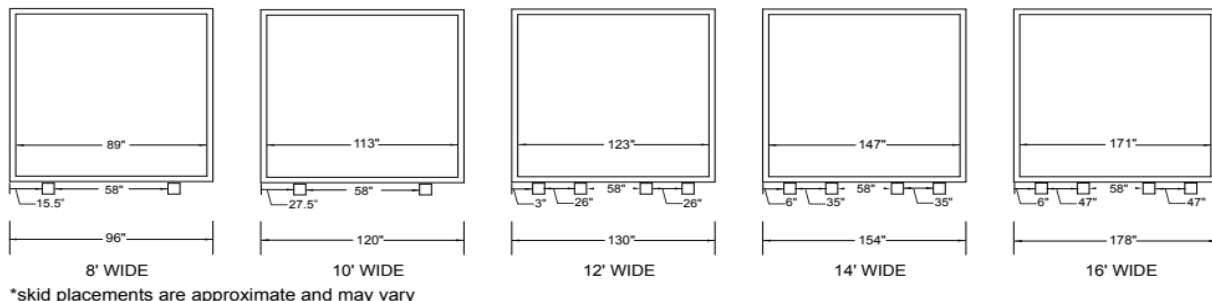

**Visit our website at cottonstatebarns.com and click on the "Dimensions" tab for more very important details and diagrams regarding our interior and exterior dimensions.*

Cotton State Barns and/or CTH Rentals, LLC., reserves the right to correct any errors or misrepresentations regarding its products, policies and/or pricing made by its employees or independent affiliates. All pricing is subject to change without notice.



RENT-TO-OWN

36, 48, & 60 MONTH CONTRACT OPTIONS

Our Rent-to-Own program allows customers to rent the barns with NO CREDIT CHECK when purchasing is not an option. There is no credit application to fill out and you are not required to keep the barn.

OWN THE BARN | After all the contract obligations are met, the barn is yours to keep.

NO CREDIT CHECKS | Low credit score? Not a problem!

STOP ANY TIME | Stop renting at any time without affecting your credit rating.

NO PENALTY FEES | Want to pay off your barn early? No problem! We won't charge you any extra fees.



6-YEAR FRONT-TO-BACK WARRANTY!

Cotton State Barns offers a 6-YEAR FRONT-TO-BACK WARRANTY on both material defects and the craftsmanship of our products on every new barn we sell! (Normal aging, wear & tear, weather related issues, customer damages, and some components provided by other suppliers are excluded.)

**Visit our website at cottonstatebarns.com and click on the "Warranty" tab for more very important details regarding our warranty policies and their limitations.*



LIMITED LIFETIME WARRANTY!

Cotton State Barns offers a limited lifetime warranty on all pressure-treated wood components regarding termite damage and fungal decay.

**Visit our website at cottonstatebarns.com and click on the "Warranty" tab for more very important details regarding our warranty policies and their limitations.*



DEALER INFORMATION



Visit us online to learn more.
COTTONSTATEBARN.COM